

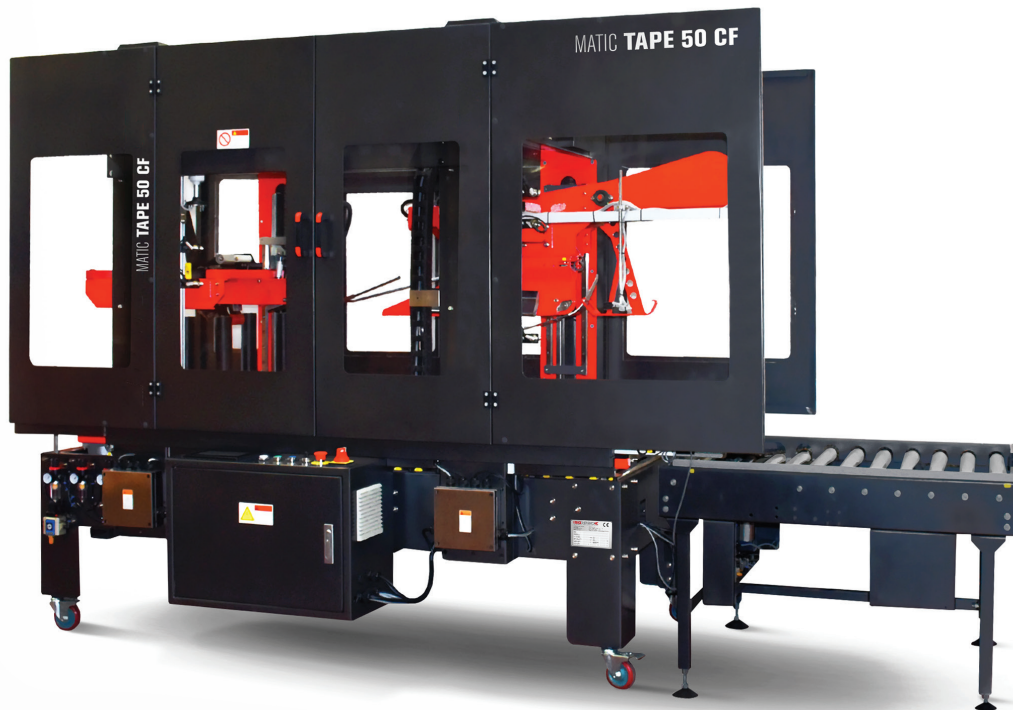

ISG>PACK
AUTOMATIC PACKAGING SYSTEM

Nastratrici per scatole

CARTON SEALERS



EASY TAPE 70 TSB



Nastratrice semiautomatica a dimensionamento manuale progettata per la nastratura di scatole di grandi dimensioni, che sigilla con nastro autoadesivo la parte inferiore e superiore di scatole a formato fisso di tipo americano. L'avanzamento della scatola avviene mediante due cinghie laterali comandate da due motori e due cinghie superiori comandate da un motore, garantendo così la massima uniformità di scorrimento. Il risultato è un perfetto allineamento delle falde e quindi una sigillatura ottimale, che viene effettuata dalle performanti teste nastranti. Corredata di rulliere in ingresso ed uscita, lama ferma scatole e ruote, costituisce una semplice e pratica postazione di imballaggio.



Semi-automatic manual adjustment carton conceived for taping big boxes, which seals the top and the bottom of American type fixed size boxes, with adhesive tape. Box feeding is regulated by two lateral belts controlled by two motors and by two top belts controlled by a motor. This system ensures the maximum sliding uniformity. The result is a perfect alignment of the flaps and optimum sealing, performed by the efficient taping heads. Machine is equipped with infeed and outfeed rollers, blade to stop the box and wheels, representing a practical and simple packaging station.

 **Macchine con dimensioni a richiesta**
Customized machines on request

 **Presenza dell'operatore**
With operator

 **Nastratura superiore/inferiore**
Top/bottom sealing

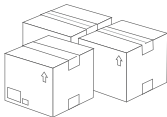
 **Cartoni monofornato**
Uniform carton

 **Disponibile in acciaio Inox**
Stainless steel version
EASY TAPE 70 TSB SS



PANNELLO DI CONTROLLO
CONTROL PANEL



TESTA DI NASTRATURA
TAPING HEAD

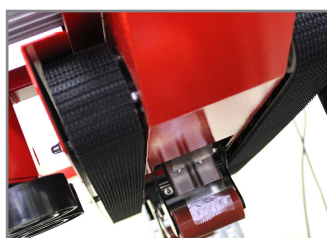

CINGHIE SUPERIORI MOTORIZZATE
TWO TOP BELT CONTROLLED BY A MOTOR



RUOTE DI SERIE
WHEELS INCLUDED

Caratteristiche tecniche

- ⊕ Peso: 180 Kg
- ⊕ Alimentazione elettrica: 220 Volts - 50 / 60 Hz
- ⊕ Velocità di trasferimento scatola: 20 mt / min
- ⊕ Peso max scatola: 30 Kg
- ⊕ Dimensioni macchina: L 2000 x W 1110 x H 1650 - 1850 mm
- ⊕ Rumorosità max: ≤ 75 db
- ⊕ Fungo di emergenza per le normative CE
- ⊕ Nastro adesivo: Kraft, Polipropilene, PVC
- ⊕ Testa nastrante standard: 50 - 75 mm
- ⊕ Altezza piano lavoro: 600 - 800 mm

Technical details

- ⊕ Weight: 180 kg
- ⊕ Power supply: 220 Volts - 50 / 60 Hz
- ⊕ Box transfer speed: 20 mt / min
- ⊕ Maximum box weight: 30 kg
- ⊕ Machine dimensions: L 2000 x W 1110 x H 1650 - 1850 mm
- ⊕ Maximum Noise: ≤ 75 db
- ⊕ Emergency stop in compliance with CE regulations
- ⊕ Adhesive tape: Kraft, Polypropylene, PVC
- ⊕ Standard taping head: 50 - 75 mm
- ⊕ Working table height: 600 - 800 mm

	DIMENSIONI SCATOLE BOX DIMENSION	
	MINIMO MIN	MASSIMO MAX
LUNGHEZZA LENGTH	150 mm	∞
LARGHEZZA WIDTH	150 mm	700 mm
ALTEZZA HEIGHT	120 mm	700 mm

	NASTRO ADESIVO ADHESIVE TAPE	
	TIPO TYPE	MASSIMO MAX
50 mm	PP PVC KRAFT	990 mt
75 mm	PP PVC KRAFT	990 mt
-	-	-

LAYOUT

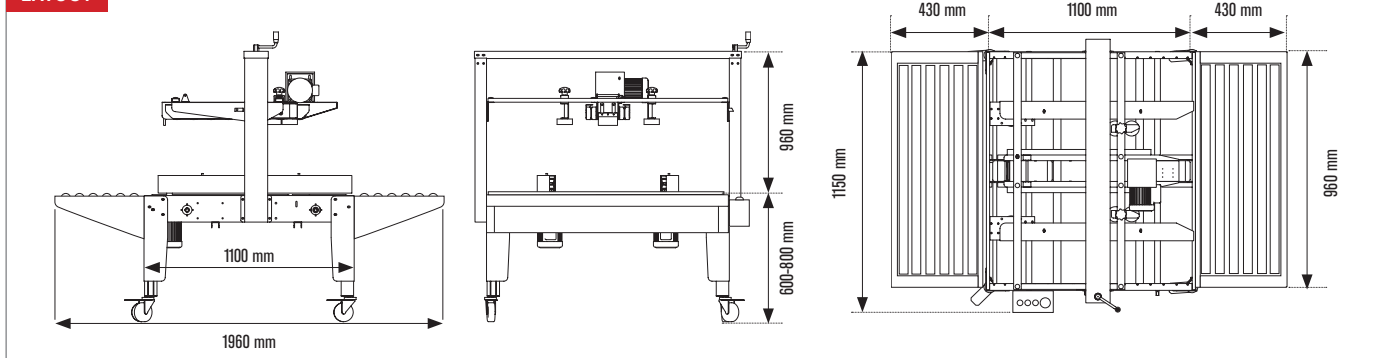

DATI TECNICI | DATA SHEET

Alimentazione elettrica | Power supply

Potenza Installata | Installed power

Pressione aria | Air pressure

Consumo aria | Air consumption

Velocità nastratura | Sealing speed

Testa nastrante | Taping head

EASY TAPE 70 TSB

220 volts - 1 ph - 50 / 60 Hz

0,60 kW

-

-

Fino a 15 scatole min | Up to 15 boxes min

50 - 75 mm

CARATTERISTICHE PRODOTTO LAVORABILE | PRODUCT FEATURES

Dimensioni min. scatole | Min box dimension

Dimensioni max. scatole | Max box dimension

Tipologia di scatole | Box type

L 150 x W 150 x H 120 mm

L ∞ x W 700 x H 700 mm

Scatole di tipo americano | American type boxes

ISG>PACK
AUTOMATIC PACKAGING SYSTEM

🌐 www.isg-pack.com @ info@imballaggiservice.com

Via Castelli Romani Km. 11,700 | Angolo Via Sassuolo, 6
00071 Pomezia | Roma | Italy
T. +39.06.9160.7561 | F. +39.06.9162.5014

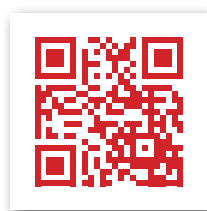

VISITA IL SITO WEB

